CASE STUDIES FROM SIMULATING MINE FIRES IN COAL MINES AND THEIR EFFECTS ON MINE VENTILATION SYSTEMS

Stewart Gillies¹ and Hsin Wei Wu²

ABSTRACT: The structure of a comprehensive research project into mine fires applying the Ventgraph mine fire simulation software, preplanning of escape scenarios and general interaction with rescue responses is outlined. The project has ACARP funding and also relies on substantial mining company site support. This is essential and allows the approach to be introduced in the most creditable way. The outcome of the completed project will be that the Australian mining industry is in an improved position in their understanding of mine fires and the use of modern advances to preplan actions to be taken in the event of mine fires and the handling of possible emergency incidents. The essential work program of the project is described and work already undertaken at individual mines discussed as examples. The effort is built around the introduction of fire simulation computer software to the Australian mining industry and the consequent modelling of fire scenarios in selected different mine layouts.

Application of the simulation software package to the changing mine layouts necessitates experience to achieve realistic outcomes. Most large Australian mines of size currently use a ventilation network simulation program. Under the project a small subroutine has been written to transfer the input data from the existing mine ventilation network simulation program to Ventgraph. This has been tested successfully. To understand fire simulation correctly the mine ventilation system must be understood correctly first. The results of the project to date are discussed.

INTRODUCTION

Mine fires remain among the most serious hazards in underground mining. The threat that fire presents depends upon the nature and amount of flammable material, the ventilation system arrangement, the duration of the fire, the extent of the spread of combustion products, the ignition location and, very importantly, the time of occurrence. The response to fire by mining personnel will depend upon all of these factors.

There is a lack of knowledge about fire/heat dynamics, some unproven technology in the field of gas sensors and no general agreement on appropriate alarm response systems and measures to be taken in the event of a significant incident. There is a need to couple the detection system with the response system. A research project has been undertaken focused on the application of mine fire and ventilation software packages for contaminant tracing and fire modelling in coal mines and validation of fire modelling software against real mine incidents to reduce the effects of fire incidents and possible consequent health and safety hazards.

With the increasing complexity of technological and managerial development of mines, the effects of mine fires must be better understood. Task Group No 4 Report arising out of the Moura No 2 coalmine disaster of August 1994 in Australia made a number of recommendations including that, *“the capability to model ventilation and the mine environment following an incident should be available at mines”*.

Following these recommendations, sub-committees were formed in 1997 to further progress various findings with Sub-Committee 5 – Incident Management given certain tasks including the question, *“that there is a need for a wider appreciation of current knowledge and improved capability of ventilation management at mines for both routine as well as emergency conditions; guidelines for modelling should include.....”*

¹ Associate Professor (Reader) in Mining Engineering, University of Queensland

² Research Fellow in Mining Engineering, University of Queensland

- *Computer modeling of post incident mine ventilation and atmosphere to be a required element in mine safety management plans,*
- *Models interface with standard mine planning packages and be kept up-to-date, and*
- *Development of learned ventilation and fire control responses occur for different incident scenarios and locations, pre-determined for each mine and with plans prepared and personnel trained in appropriate action plans”.*

The primary objective of the study has been to implement a program of research into this complex area utilizing the recently upgraded Polish mine fire simulation software, “Ventgraph”. There is a need to understand the theory behind the simulation program and to allow use by those already familiar with the main existing mine ventilation analysis computer program “Ventsim” currently popular within the Australian industry. “Ventsim” was not designed to handle fire simulation or in fact compressible flow effects in mine networks but can be used as an aid to incident and emergency management.

When a fire occurs outside the working section, the immediate safe evacuation of miners should always be the first action during the rescue operation. Usually, the intake entries are dedicated as the primary escapeways from the working section. In many cases, the dedicated escapeways are contaminated with fire by-products from abutting entries (eg, belt entry) due to interconnection or leakage through stoppings. It is important to keep these escapeways unobstructed and free from contamination.

It is difficult to predict the pressure imbalance and leakage created by a mine fire due to the complex interrelationships between the mine ventilation system and a mine fire situation. Depending on the rate and direction of dip of the entries (dip or rise), reversal or recirculation of the airflow can occur because of convection currents (buoyancy effect) and constrictions (throttling effect) caused by the fire. This reversal jeopardizes the functioning of the ventilation system. Stability of the ventilation system is critical for maintaining escapeways free from contamination and therefore available for travel.

Simulation software has the great advantage that underground mine fire scenarios can be analysed and visualized. The “Ventgraph” program is described by Trutwin, Dziurzynski and Tracz (1992). The software provides a dynamic representation of the fire's progress (in real-time) and utilizes a colour-graphic visualization of the spread of combustion products, oxygen and temperature throughout the ventilation system. During the simulation session the user can interact with the ventilation system (eg, hang brattice or check curtains, breach stoppings, introduce inert gases such as those generated by a GAG unit and change fan characteristics). These changes can be simulated quickly allowing for the testing of various fire-control and suppression strategies. Validation studies on “Ventgraph” have been performed using data gathered from a real mine fire as undertaken by Wala, et al (1995).

The simulation program has recently been put in a “Windows” format for ease of use and interrelation with other software and with some ability for transferring mine ventilation planning data from programs such as “Ventsim”.

The outcome of the project will be that the Australian mining industry is in an improved position in their understanding of mine fires and the use of modern advances to pre-plan actions to be taken in the advent of mine fires and the handling of possible emergency incidents. The goals of the project are built around the introduction of a modern fire simulation computer program “Ventgraph” and the consequent modelling of fire scenarios in a number of different mine layouts.

The project is undertaking simulations of the effects of common fire causes and fire progress rates. It is undertaking further validation of the simulation model through back-modelling of past fires where gas and other relevant data records are available. It is undertaking some simulation testing exercises incorporating the GAG and other inertisation methods. The simulation of safe escape scenarios before or during a fire as part of emergency evacuation is being examined. Some reference is being made to work undertaken by appropriate bodies such as mines' rescue organizations during pre-planning as part of mine rescue and recovery strategies. Preparation of education (teaching) and training materials on the theory of mine fires (interactions between fire and ventilation and conversely, between ventilation and fire and so on), controlling and combating mine fires, development of evacuation management plans (escape ways) is occurring as part of a technology transfer thrust.

An overview on the findings and results of the project to date and an examination of the effects of fires on mine ventilation systems using numerical fire simulation software such as “Ventgraph” is presented. Various case studies based on the modelling of fire scenarios in a number of different mine layouts are discussed.

EFFECTS OF FIRES ON MINE VENTILATION

An open fire causes a sharp increase in the temperature of the air. The resulting expansion of the air produces a number of distinct effects. First the expansion attempts to take place in both directions along the airway. The tendency to expand against the prevailing direction produces a reduction in the airflow. Secondly, the expansion in volume increases air velocity downwind from the fire causing additional pressure loss, this is known as the choke or throttle effect. Finally, the decreased density results in the heated air becoming more buoyant and causes local effects as well as changes in the magnitudes of natural ventilating energy.

The Choke or Throttling Effect

This effect results from an increase in volume of air as it passes through the fire. This increase in volume is due to gas expansion as well as the addition of combustion products such as fire gases and evaporated water. As a result the velocity of air downwind from the fire is increasing and additional pressure loss following the square law.

The choke effect is analogous to increasing the resistance of the airway. For the purposes of ventilation network analyses based on a standard value of air density, the raised value of this "pseudo resistance", R_t , can be estimated in terms of the air temperature as follows (McPherson, 1993).

$$R_t \propto T^2$$

The value of R_t increases with the square of the absolute temperature (T). However, it should be recalled that this somewhat artificial device is required only to represent the choke effect in an incompressible flow analysis.

Litton et al (1987) have produced an estimate of the increased resistance in terms of the carbon dioxide evolved from a fire. Because the temperature of fumes falls off rapidly downwind of the fire, the choke effect is generally limited to the vicinity of the fire. Thus, the magnitude of the flow constriction (choke or throttle) is likely to be small when compared to the ventilation pressure in the mine ventilation system.

According to the studies undertaken in USA and Japan, reduction of flow and velocity of air due to the choke effect can be in the range of 10 to 25% of the flow before the fire started. Even at this level it can create secondary hazards like accumulation of contaminants, inadequate oxygen content and smoke roll-back.

Buoyancy (Natural Draft) Effects

Local or Roll Back effect

The most immediate effect of heat on the ventilating air stream is a very local one. The reduced density causes the mixture of hot air and products of combustion to rise and flow preferentially along the roof of the airway. The pronounced buoyancy effect causes smoke and hot gases to form a layer along the roof and, in a level or descensional airway, will back up against the direction of airflow as shown in Figure 1.

This phenomenon of roll-back creates considerable difficulties for firefighters upstream from the fire, particularly if the conflagration has become fuel-rich. The roll-back is visually obvious because of the smoke. However, it is likely to contain hidden but high concentrations of carbon monoxide and other toxic or explosive gases. Furthermore, the temperatures of the roll-back may initiate roof fires of any combustible material above the heads of firefighters. The most critical danger is that tidal flames or a local explosion may occur throughout the roll-back, engulfing firefighters in burning gases.

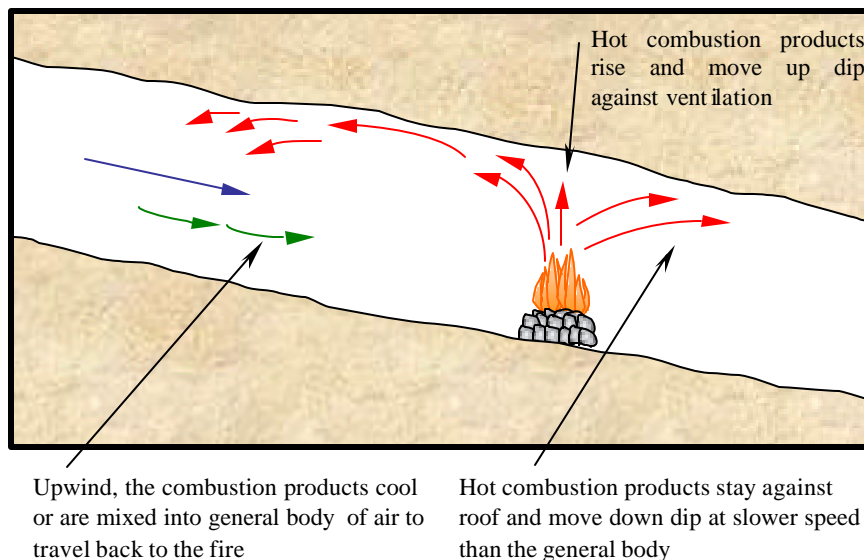

Fig 1 - Buoyancy effect of fires in descensional airway (after Bofinger, 1998)

Smoke will roll-back against low airflows, except in a rising airway. How fast and far smoke rolls back depends on how much lower the air velocity is from the minimum air velocity listed in the following table as suggested by Mitchell (1990).

Table 1 - Minimum air velocity for roll-back occurrences (after Mitchell, 1990)

Height of Entry (m)	Minimum Air Velocity, (m/s)		
	Dip 0%	Dip 10%	Dip 20%
1.2	1.00	1.20	1.50
1.8	1.25	1.45	1.80
2.4	1.40	1.68	2.10
3.0	1.60	1.88	2.35

One method of reducing roll-back is to increase the airflow in the airway. This, however, will increase the rate of propagation of the fire. A second method is to advance with hurdle cloths covering the lower 60 to 80 per cent of the airway. The increased air velocity at roof level will help to control the rollback and allow firefighters to approach closer to the fire. However, this technique may also cause the roll-back gases to mix with the air and produce an explosive mixture on the forward side of the hurdle cloth. Furthermore, the added resistance of the hurdle cloth might reduce the total airflow to the extent that a fuel-rich situation is promoted. The behaviour of open fires is very sensitive to modifications to the airflow. Hence, any such changes should be made slowly, in small increments, and the effects observed carefully.

A third method of combating roll-back is to direct fog sprays towards the roof. In addition to wetting roof material and cooling smoke laden air, the air induction effects of the sprays will assist in promoting airflow in the correct direction at roof level. However, it should be noted that sprays would cool the rock surface and possible cause spalling.

Whole mine Natural Ventilation Pressure effects

A more widespread effect of reductions in air density is the influence felt in shafts or inclined airways. The conversion of heat into mechanical energy in the ventilation system is called the buoyancy (natural draft, natural ventilating pressure or chimney) effect. Such a conversion under steady state conditions requires cyclic processes that are provided by every loop of the ventilation network.

The effect is most pronounced when the fire itself is in a shaft or inclined airway and promoting airflow if the ventilation is ascensional and opposing the flow in descensional airways. Indeed, in the latter case, the airflow may be reversed and can result in uncontrolled recirculation of toxic atmospheres.

Natural ventilating pressure always exist in a mine and its magnitude mostly depends on the mine's depth and difference between the temperatures of the air in downcast and upcast shafts. In the case of fire, this effect is magnified due to high temperatures leading to unpredictable changes in the airflow distribution.

If the air temperatures can be estimated for paths downstream of the fire then it is possible to determine the modified natural ventilating pressures. Those temperatures vary with respect to size and intensity of the fire, distance from the fire, time, leakage of cool air into the airways affected and heat transfer characteristics between the air and the surrounding strata.

At any given time, air temperatures tend to fall exponentially with respect to distance downstream from a fire. Climatic simulation models may also be employed to track the time transient behavior of air temperatures downstream from a fire, however; in that case, two matters should be checked. One is that the limits of application of the program may be exceeded for the high temperatures that are involved. Secondly, the transient heat flux between the air and strata will be much quicker than for normal climatic variations. Hence, the virgin rock temperature (VRT) in the simulation input should be replaced by a "surrounding rock temperature" (SRT), this being an estimate of the mean temperature of the immediate envelope of rock around the airway before the fire occurs.

Having determined air temperatures in all paths downstream from the fire, the revised natural ventilation pressures for the mine can be determined. These may then be utilized in network analysis exercises to predict the changes in flow and direction that will be caused by a fire of given output. A number of fire simulation packages have been developed to allow numerical modelling of mine fires (e.g. Greuer, 1984; Greuer, 1988; Dziurzynski et al, 1988; Deliac et al, 1985; Stefanov et al, 1984).

Case Studies of Australian Longwall Development Panels

One of the major goals of the study is to examine the effects of fires on mine ventilation systems. To demonstrate how the choke or throttling and buoyancy effects influence mine ventilation systems, fire scenarios were simulated for several case studies based on a typical Australian two entries longwall development panel with various panel configurations.

Panel configurations varied in the case studies including development panel length of 1.5 km or 3 km with panel dipping angles of plus and minus 5 degrees and 10 degrees. To generate a uniform ventilation airflow of 22.8 m³/s through the panel at the working face, a differential pressure equal to 70 Pa was introduced across the stopping at the first cut-through between intake and return entries for the 1.5 km panel length cases studied and a differential pressure of 235 Pa was used for the 3 km panel cases studied.

Figure 2 shows typical two-entry longwall development panel ventilation systems with various panel lengths of 1.5 and 3 km. The fresh air reaches the face through one entry and exhausts from the face through the other, which is the belt entry. The fresh air entry is isolated from the return entry by a series of short life stoppings.

Table 2 shows a summary of the simulation results with diesel fires set in the middle of the development panel for each case study at either intake or return airways. The fire has a 5m fire zone length, a fire intensity of 10 and a time constant of 120 seconds. This is assumed that the fire is spreading (building-up) with a given time constant to reach the given visible fire area and with an intensity of fire i.e., the amount of fuel burning during the fire in the scale of 1 to 10. There were two cases under which the face airflow almost reversed.

When the diesel fire is set in the middle of the return airway at nodal points 24-25 in the 1.5 km longwall development panel mining on a 10% incline upward. The buoyancy effect of the fire acted against the fan pressure but was not enough to overtake the fan pressure to reverse the airflow. As the airflow reduced, the oxygen supplied to the fire is decreased. This caused a significant reduction of the magnitude of the fire thus the buoyancy effect of the fire working against the fan pressure is then reduced. All this means is that now there is more air available to the fire so the fire starts to grow again. This can be observed in the fire simulation output graphic and is illustrated in Figure 3 showing the heat production of the fire during simulation. It can be noted from the figure that the fire causes a sharp reduction in the airflow entering the development panel. In the case of a mine with high seam methane levels this will lead to higher gas levels in the mine air.

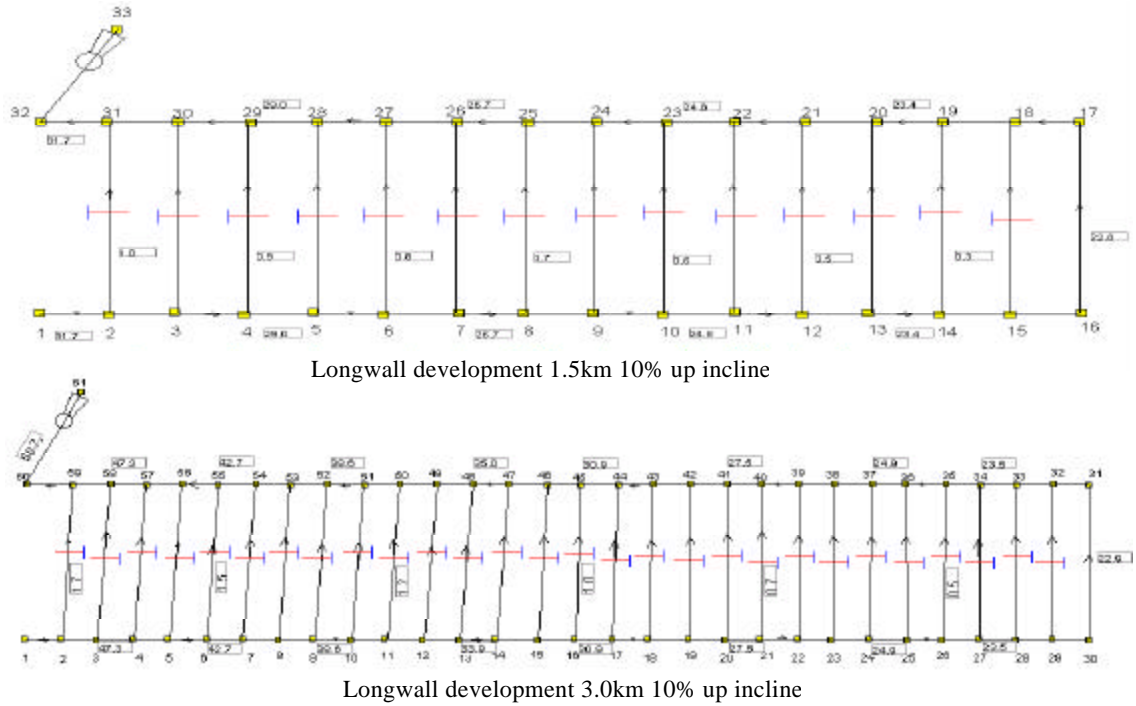

Fig 2 - Two-Entry Longwall Development Panels

Table 2 - Summary of simulation results for 5m -fire zone

Panel Length	Panel Inclination		Face Q m ³ /s		Air Reversal
			Initial	Final	
Fire at return airways (branch 24-25 or 45-46)					
1.5km	5%	Up	22.8	16.1	No
1.5km	5%	Down	22.8	25.7	No
1.5km	10%	Up	22.8	1.3	Almost
1.5km	10%	Down	22.8	30.2	No
3.0km	5%	Up	22.8	21.3	No
3.0km	5%	Down	22.8	24.4	No
3.0km	10%	Up	22.8	20.1	No
3.0km	10%	Down	22.8	24.5	No
Fire at intake airways (branch 8-9 or 14-15)					
1.5km	5%	Up	22.8	26.7	No
1.5km	5%	Down	22.8	16.2	No
1.5km	10%	Up	22.8	29.3	No
1.5km	10%	Down	22.8	1-1.3	Almost
3.0km	5%	Up	22.8	24.3	No
3.0km	5%	Down	22.8	21.4	No
3.0km	10%	Up	22.8	25.7	No
3.0km	10%	Down	22.8	19.4	No

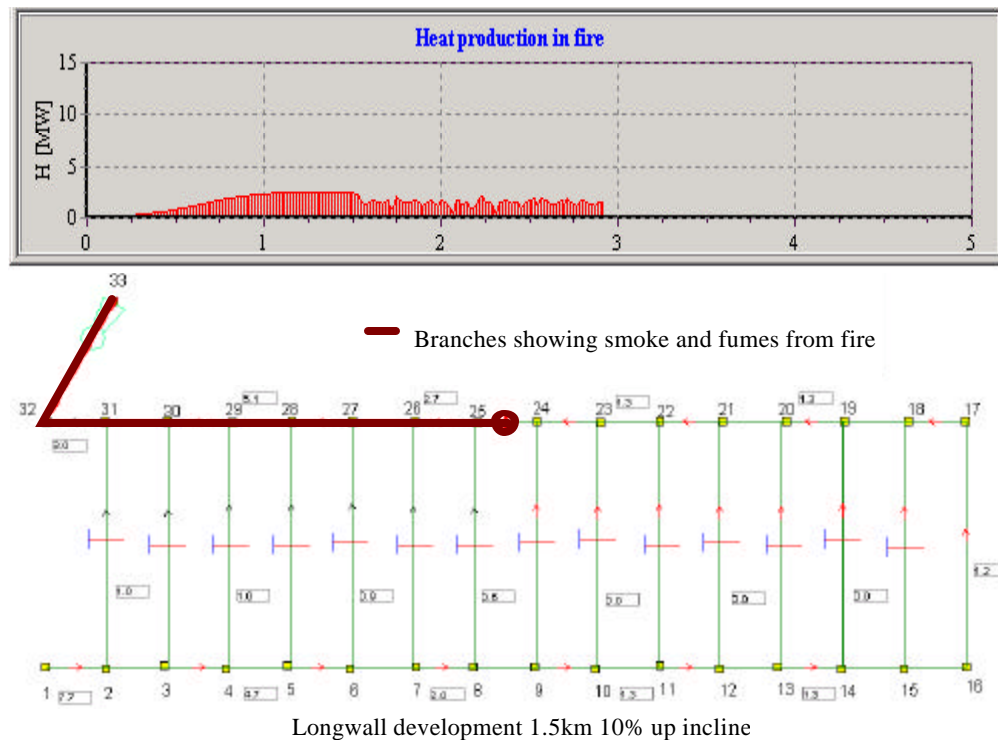

Fig 3 - Smoke progressions and heat production during simulation for 5m long fire zone in return roadway.

When the fire was in the intake airway at nodal points 8-9 in the 1.5 km longwall development panel mining at a 10% decline down. Again, the buoyancy effect of the fire acting against the fan pressure was not enough to overtake the fan pressure to reverse the airflow. The airflow at the faces in both cases was drastically reduced to approx. 1-1.3 m³/s.

The simulations were re-run for these cases with a 10m fire zone length instead of 5m and a summary of results is shown in Table 3. Airflow reversals at the face were observed in the 10% incline case with fire in return airway and also with 10% decline with fire in the intake airway. Figure 4 shows how the smoke progressed and the amount of heat produced during different stages of the fire simulated in the 10% incline case with fire in return air. It is noted that a reduction in heat production from the fire was observed before the airflow reversal occurred. As the products of fire are forced past or over the fire at the moment when airflow reversal occurs, the amount of oxygen available to the fire is drastically decreased.

Table 3 - Summary of simulation results for 10m-fire zone

Panel Length	Panel Inclination	Up/Down	Face Q m ³ /s		Air R eversal
			Initial	Final	
Fire at return airways (branch 24-25 or 45-46)					
1.5km	5%	Up	22.8	4.1	No
1.5km	5%	Down	22.8	29.0	No
1.5km	10%	Up	22.8	16.8*	Yes
1.5km	10%	Down	22.8	33.4	No
3.0km	5%	Up	22.8	20.9	No
3.0km	5%	Down	22.8	24.6	No
3.0km	10%	Up	22.8	18.4	No
3.0km	10%	Down	22.8	26.2	No
Fire at intake airways (branch 8-9 or 14-15)					
1.5km	5%	Up	22.8	28.1	No
1.5km	5%	Down	22.8	3.5	No
1.5km	10%	Up	22.8	36.6	No
1.5km	10%	Down	22.8	1.5-4.5*	Yes
3.0km	5%	Up	22.8	24.9	No
3.0km	5%	Down	22.8	20.6	No
3.0km	10%	Up	22.8	27.4	No
3.0km	10%	Down	22.8	16.0	No

* Air flows in opposite direction to initial flow direction.

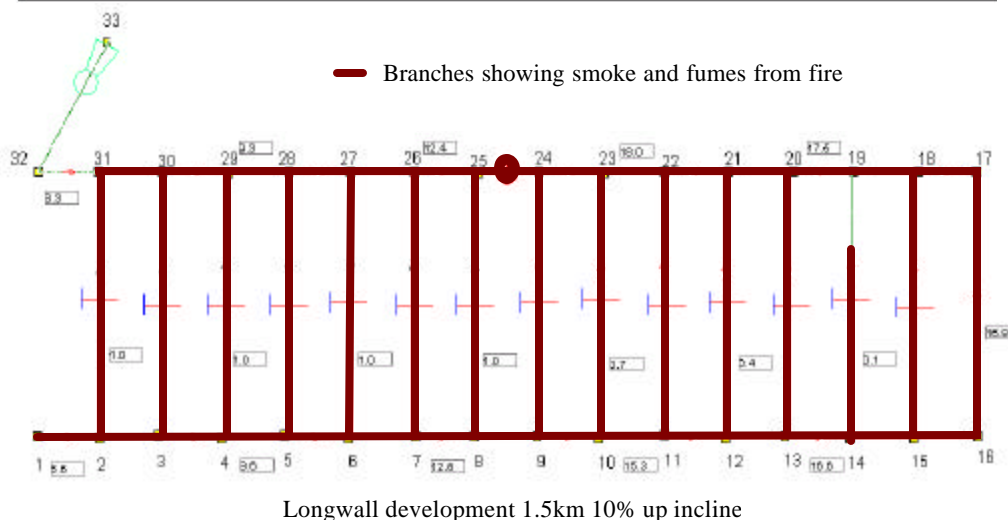
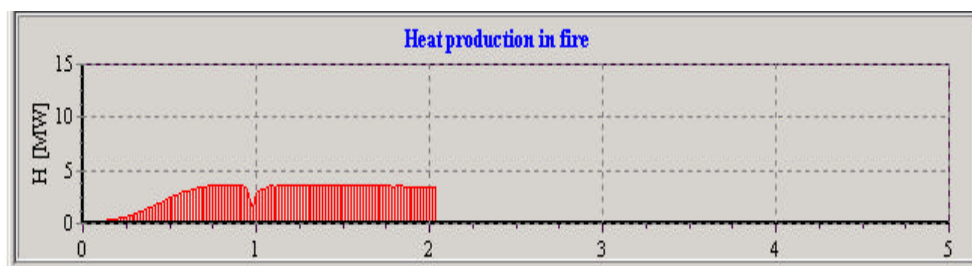

Fig 4 - Smoke reversal and heat reduction observed during simulation for 10m long fire zone in return roadway

MODELING OF FIRES

One of the immediate questions about fire simulation is the magnitude of the fire and how the fire can be modeled in the simulator. In the simulator, various fires can be modeled through combinations of the types of fuels, the length of fire zone (surface area) and intensity. It is necessary to investigate the effects of the length of fire zone and fire intensity on the mine ventilation system. Validation exercises were undertaken to establish how location, type and intensity of fires could be established and modeled.

As for the intensity of diesel fuel fire according to Dziurzynski ¹, some empirical work had been undertaken to establish the amount of heat produced by various types of fuels. For example, 20 litres of diesel fuel was burned in a pool of a surface of 1.72 m². This amount of diesel fuel burned for 17 minutes in an air velocity of 1.5 m/s. With a calorific value of 34 MJ per litre for diesel fuel, a total of 680 MJ of energy was produced. With a burning time of 17 minutes, this means that the heat production averaged at 0.67MW (680MJ/1,020 seconds).

It is understood that with a larger surface area the fire would burn faster and with a larger amount of the fuel available, the fire would burn longer. For example, if 1,000 litres of diesel is available for the same surface areas, the fire will last 850 minutes with a constant burn rate of 0.02 l/s and heat output of 0.67 MW instead of 17 minutes for 20 litres fuel with the same burn rate and heat output. Similarly, if the fuel is spread over a larger surface area say 10m² then it will burn at a fast rate providing that there is an abundant oxygen supply. In this case, the fire will only last for 146 minutes but with a much faster burning rate (0.114 l/s) and a higher heat output (3.88 MW) from the fire. Table 4 shows a summary of calculated heat productions for various combinations of surface areas and amount of fuels available.

According to Yung ², approximately 1 m³/s of air is required for every 1 MW of heat produced from a fire, if the fire is not to be air/oxygen starved. Based on this, it is possible to calculate the minimum amount of air required to sustain a fire without oxygen deficiency. The minimum air quantity is also calculated and included in Table 4.

Table 4 - Prediction of heat outputs from various fires

Fuel (l)	Area (m ²)	Burn time		Rate (l/s)	Heat Output		Q _a m ³ /s
		(min)	(s)		(MW)	(MW/hr)	
20	1.72	17	1020	0.020	0.67	0.19	0.67
1000	1.72	850	51000	0.020	0.67	9.44	0.67
1000	10	146	8772	0.114	3.88	9.44	3.88
458	25	27	1607	0.285	9.69	4.33	9.69
818	50	24	1435	0.570	19.38	7.73	19.38
1020	100	15	877	1.140	38.76	9.63	38.76

Several simulation exercises were carried out to examine the relationship between the length of fire zone and the heat production predicted by the simulator. For each of the exercises, a diesel fire was used with an intensity of nominal value 10. Three lengths of fire zone were tested namely, 25m, 50m and 100m. The fires were set in a horizontal airway with about 25 m³/s of air initially. The fires were simulated for about 160 minutes to let the fires become stable. Areas under the heat production charts were measured and average heat outputs for the first one-hour period and the whole period were obtained. Based on heat production predicted by the simulator, it is possible to calculate the amount of fuel burned during the exercises, these are shown in Table 5.

The values for amount of fuel burned and averaged heat production in the fire for the first hour as shown in Table 5, compare well with the values calculated in Table 4. Therefore, it should be possible to model the magnitude of various fires by varying the length of fire zone.

¹ Personal Communication D. Ziurzynski 2003

² Personal Communication Yung D. 2003 CSIRO North Ryde

Table 5 - Prediction of heat production and fuel burnt

Length (m)	Average Heat Output		Fuel Burned (l)
	Whole (MW)	1st hr (MW)	
25	5.26	4.32	458
50	8.86	7.73	818
100	8.97	9.64	1020

LONGWALL VENTILATION CASE STUDIES

Typical Aspects of Australian Longwall Mining

An example of the layout of an Australian longwall mine is shown in Figure 5. In terms of ventilation nomenclature intake roadways are shown as solid, single arrow roadways whereas return roadways are shown as dashed, double arrow roadways. In this case a raisebore exists behind the current goaf and is shown as a circle with an intake roadway connecting to the longwall face roadway (Mayes and Gillies, 2002). Australian longwalls at present normally use twin headings for development and have typically between five and seven Mains roadways. In longwall development, A Heading (as shown in Figure 5) is an intake roadway with B Heading the return roadway through which the panel conveyor runs.

In the Mains, B, C, and D Headings are typically intake with flanking return roadways, A and E Headings. When all longwalls are being extracted on one side of the Mains only, D and E Headings may be used as return roadways with A, B and C Headings as intake roadways. The conveyor runs in the intake headings, typically in C Heading. In Queensland this roadway is segregated from either one or both of the other intake roadways.

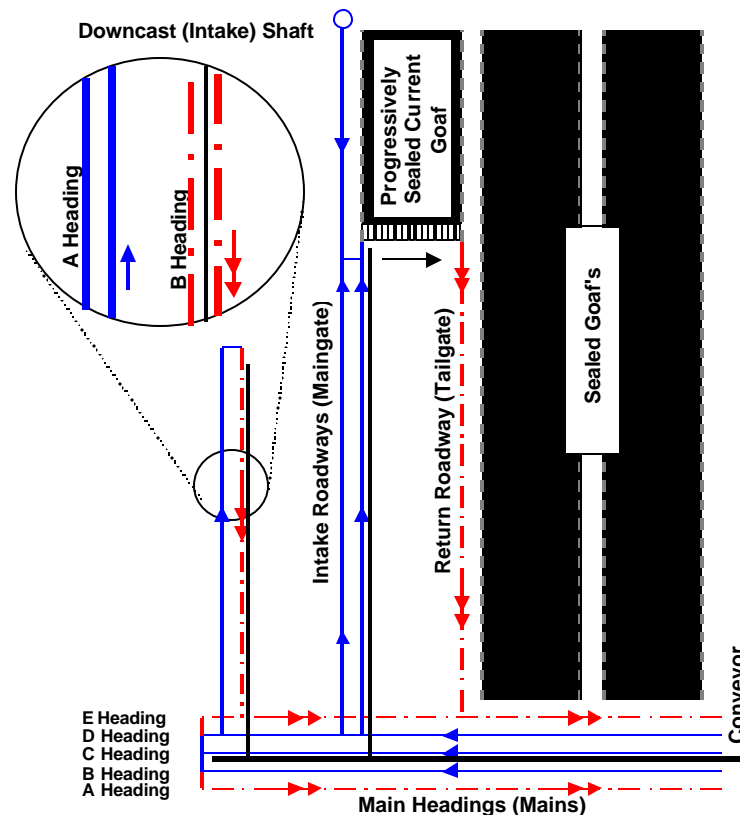

Fig 5 - Typical Layout of Australian Longwall Mining (After Mayes and Gillies, 2002)

Mine Ventilation Circuits and Diagonal Connections

Ventilation systems in an operating mine generally consists of an arrangement of multiple, interconnected airway. In most of the cases, airways are interconnected by cutthroughs. In this case cutthrough can be termed a "diagonal" airway and the mine ventilation network is much more complicated than the usual parallel and/or series network.

The airflow through the diagonal connection can be unstable, and its direction depends on the resistances of the branches interconnected with it. Diagonal connections almost always exist in a mine ventilation network; however, good planning can decrease the total number of these branches. Usually it is not possible to eliminate all of them, but it is important to recognize the instability problems associated with their existence and to pay attention to their effect on the mine ventilation network.

The stability of the airflow through the diagonal connection is related to the resistance of the airways interconnected with the diagonal branch which is well known as the basic Wheatstone Bridge balance conditions for electrical circuits as shown in Figure 6. These relationships are as follows:

- a) No flow in the diagonal branch

$$\frac{R_1}{R_2} = \frac{R_3}{R_4}$$

- b) Flow from A to B in the diagonal branch

$$\frac{R_1}{R_2} < \frac{R_3}{R_4}$$

- c) Flow from B to A in the diagonal branch

$$\frac{R_1}{R_2} > \frac{R_3}{R_4}$$

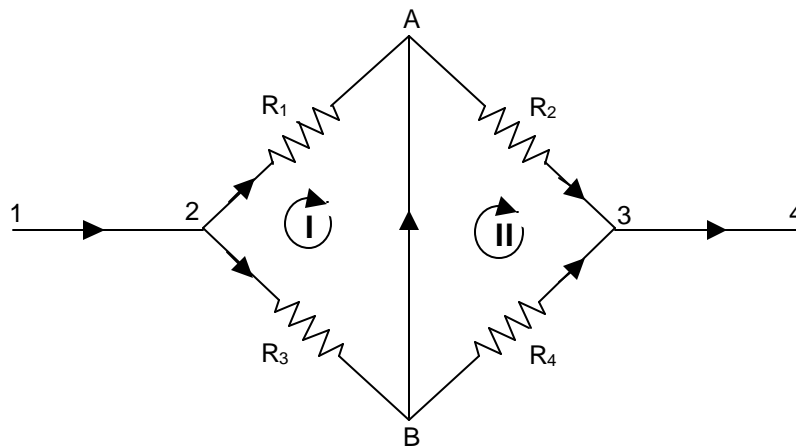

Fig 6 - Ventilation network circuit - Wheatstone bridge

A typical situation where a diagonal connection exists in Australian coal mines is shown in the following diagram. The diagonal connection is established when the next longwall block face road holes through to the existing longwall panel.

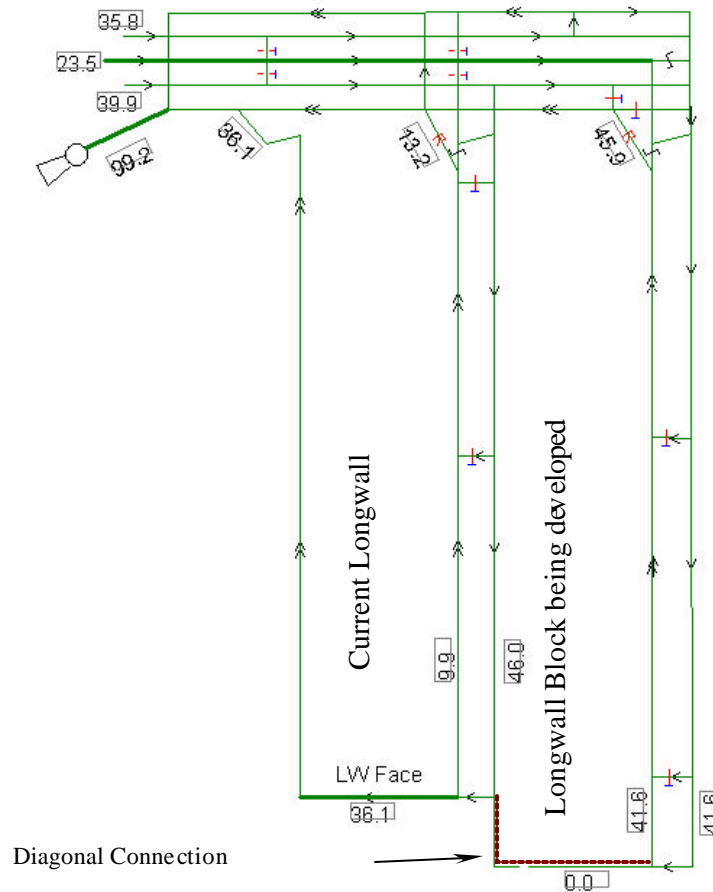

Fig 7 - A typical diagonal connection in Australian coal mine

Case studies were undertaken to simulate the effects of fires on the simplified ventilation circuits before and after the next longwall face road holed through and created an airflow connection to the current longwall circuit. Figure 8 shows how the smoke progresses compared to Figure 7 if a diesel fire with a 30m length of fire zone, a fire intensity of 10 and a time constant of 120 seconds is started 50m outby of the current longwall face. In this case, the fire affects only the current longwall face.

Once the next longwall block face road holes through, an airflow ventilation connection is established. In this case, $2.2 \text{ m}^3/\text{s}$ of air flows from next longwall block to the current longwall panel when the same fire is set at the same location for this case. It was found the fire will affect both current longwall and the next longwall development blocks, after the diagonal connection is established, as fire causes the reversal of airflow through the diagonal connection as shown in Figure 9 when compared to Figure 7. The fire here generates a net buoyancy effect on the airflow in the current longwall maingate. This causes an increased air pressure, which causes air to flow in reverse into the next longwall faceline.

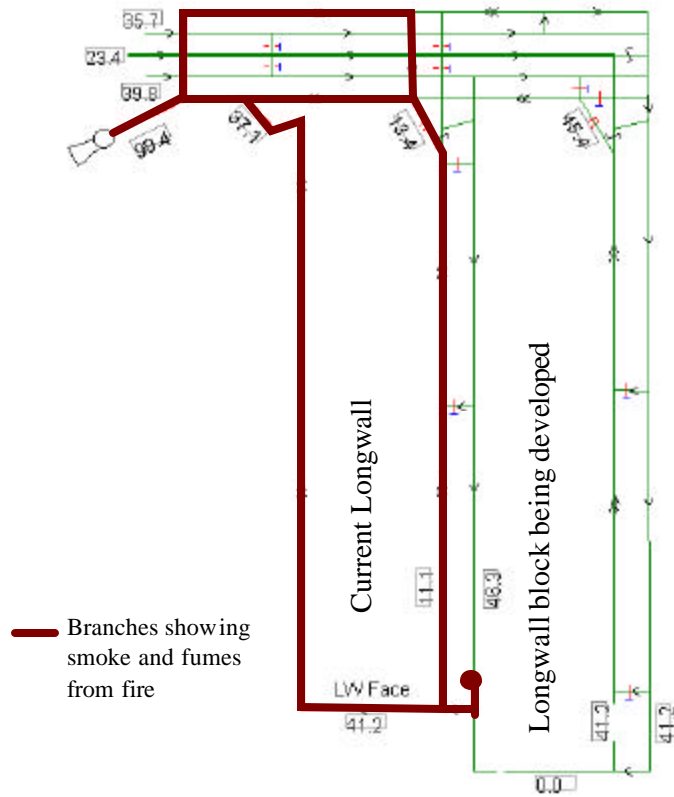

Fig 8 - Smoke progression without diagonal connection

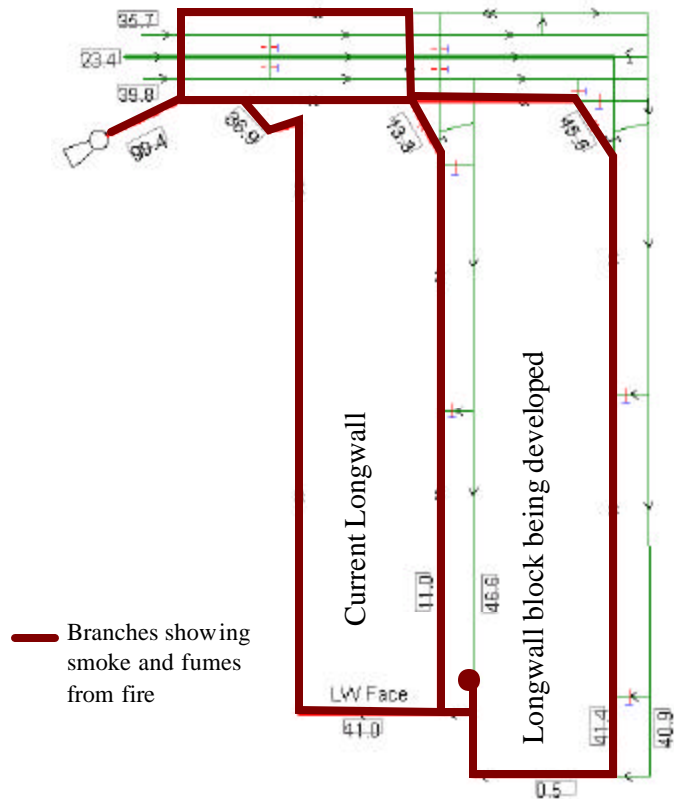

Fig 9 - Smoke progression with diagonal connection

There are two possible situations when diagonal branches can adversely affect the ventilation system (Wala, 1999):

1. When a diagonal connection already exists and a flow reversal or stagnation occurs due to the resistance changes around it (this is illustrated in the above case where the fire causes a net buoyancy change).
2. When a diagonal branch is added that can cause airflow redistributions in the surrounding branches.

It is important to identify the presence of existing or potential diagonal connections within the mine ventilation network as the airflow through the diagonal connections could reverse or stop, due to changes in the adjoining branches within the ventilation network. In some case, contaminated air may attempt to flow into the working areas. However, the existing diagonal branches could be useful during fire fighting or mine rescue operations, where, by alteration of the flow direction in a diagonal branch it is possible to deliver fresh air to areas where it is needed, or to redirect the contaminated air away from working areas where adverse efforts would otherwise result, if the contaminated air was present.

CONCLUSIONS

A comprehensive research project into mine fires funded by the Australian Coal Association Research Program with substantial mining company site support has been carried out. The project involved applying the "Ventgraph" mine fire simulation software, preplanning of escape scenarios and general interaction with rescue responses. Mine site testing is essential and allows the approach to be introduced in the most credible way. Outcomes to date from the project have been detailed.

The project is intended to assist the Australian mining industry to attain an improved position in their understanding of mine fires and the use of modern advances to preplan for mine fires and possible emergency incidents. Examples of work undertaken so far at individual Australian coal mines has been discussed. The effort is built around the introduction of fire simulation computer software to the Australian mining industry and the consequent modelling of fire scenarios in selected different mine layouts.

Application of the simulation software package to changing mine layouts requires experience to achieve realistic outcomes. Most Australian large size mines currently use a ventilation network simulation program. Under the project a small subroutine has been written to transfer the input data from the existing mine ventilation network simulation program to "Ventgraph". This has been tested successfully. To understand fire simulation behaviour on the mine ventilation system, it is necessary to understand the possible effects of mine fires on various mine ventilation systems. Case studies demonstrating the possible effects of fires on some typical Australian coal mine ventilation circuits with diagonal connections have been discussed. It is important to identify and understand these potential effects on the mine ventilation network as the airflow through the diagonal connections could reverse or stop due to the changes in the adjoining branches within the ventilation network. Mining companies need to identify the existing and potential diagonal connections in their ventilation system and analyse how these connections will affect their ventilation system especially in the case of fires. Training is necessary to equip mine ventilation personnel how to identify and minimize diagonal connections in their ventilation system.

ACKNOWLEDGEMENT

The support of the University of Queensland, Australian Coal Association and a number of operations within the Australian mining industry in funding this study are acknowledged.

REFERENCES

- Bofinger, C. 1998. *Mine Fires in Australian Underground Coal Mines*. Queensland: Safety In Mine Testing and Research Station (SIMTARS).
- Deliac, E.P., Chorosz, G., and D'Albrand, N. 1985. Development of Ventilation Software on Personal Computers in France and the Application to the Simulation of Mine Fires. *2nd U.S. Mine Vent. Symp.* Reno, Nevada. pp 19-27.
- Dziurzynski, W., Tracz, J. and Trutwin, W., 1988. Simulation of Mine Fires. *4th Int. Mine Vent. Cong.* (Ed, A.D.S. Gillies) Brisbane, Australia. pp 357-363.
- Greuer, R.E. 1984. Transient-State Simulation of Ventilation Systems in Fire Conditions. *3rd Int. Mine Vent. Cong.* Harrogate, U.K. pp. 407-410.
- Greuer, R.E. 1988. Computer Models of Underground Mine Ventilation and Fires. *U.S. Bureau of Mines: IC 9206 (Recent Developments in Metal and Non-Metal Mine Fire Protection)*. pp. 6-14.
- Litton, C.D. Derosa, M.I., and Li, J.S., 1987. Calculating Fire-Throttling of Mine Ventilation Airflow, *U.S. Bureau of Mines Report RI 9076*.
- McPherson, M.J. 1993. *Subsurface Ventilation and Environment Engineering*. New York: Chap & Hall.
- Mayes, T.I. and Gillies, A.D.S. 2002. Economic Modeling of Australian Longwall Ventilation, Mine Ventilation – *Proc. North American 9th US Mine Vent. Symp.*, De Souza (Ed), Netherlands: Balkema.
- Mitchell, P.E. 1990. *Mine Fires – Prevention, Detection, Fighting*. Chicago: MacLen Hunter Publishing Co.
- Stefanov, T.P, 1984. Unsteady-state Processes during An Open Fire in a Ventilation Network. *3rd Int. Mine Vent. Cong.* Harrogate, U.K. pp. 417-420.
- Trutwin, W., Dziurzynski, W. and Tracz, J. 1992. Computer Simulation of Transients in Mine Ventilation. *Proc. 5th Int. Mine Vent. Cong.* (Ed. R. Hemp). pp.193-200.
- Wala, A., Dziurzynski, W., Tracz, J. and Wooton, D. 1995. Validation Study of the Mine Fire Simulation Model. *Proc. 7th US Mine Vent. Symp.* Society of Mining Engineers: (Ed. A. Wala) 1995. pp.199-206.
- Wala, A.M. 1996. Controlling Ventilation for Safe Escape from Coal Mine Fires. *Mining Engineer*. April. pp. 61-66.
- Wala, A.M. 1999. Three Underground Coal Mine Explosions – Twenty Miners Killed – One Reason, *Proc. 8th US Mine Vent. Symp.* Rolla, Missouri. 11-17 June 1999. Missouri-Rolla: University of Missouri-Rolla Press.